

10. - 12. July 2010

96th TrendSet — International Trade Fair for Living, Dining, Lifestyle

TrendSet GmbH
 Ismaninger Straße 63
 81675 Munich
 Germany

Exhibitor
Contact
Address
Postal Code, City/Town
Phone Number
Fax Number
Mobile Phone Number
E-mail Address
Internet



Contents of the Technical Order

Please indicate with ticks in the boxes below all forms you have filled out, and send this page to us with your order.

<input type="checkbox"/>	1.1 Electrical Connection	2
<input type="checkbox"/>	1.2 Electrical Connection (Accessories)	3
<input type="checkbox"/>	1.3 Electrical Connection (Diagrams)	4
<input type="checkbox"/>	2.1 Stand Type/Construction	5
<input type="checkbox"/>	2.2 Additional Fittings	6
<input type="checkbox"/>	3 Stand Assembly	7
<input type="checkbox"/>	4.1 Carpeting	8
<input type="checkbox"/>	4.2 Colour Choices for Carpeting	9
<input type="checkbox"/>	5.1 Furniture—Chairs	10
<input type="checkbox"/>	5.2 Furniture—Tables	11
<input type="checkbox"/>	5.3 Other Furniture	12
<input type="checkbox"/>	5.4 Furniture (Diagrams)	13
<input type="checkbox"/>	6 Telecommunications Connection	14
<input type="checkbox"/>	7 Water Connection	15
<input type="checkbox"/>	8 Badges	16
<input type="checkbox"/>	9 Trend Display Cubicle or Glass Display Case Between Halls	17
<input type="checkbox"/>	10 Other Services	18

Place, Date

Signature

10. - 12. July 2010

96th TrendSet — International Trade Fair for Living, Dining, Lifestyle

TrendSet GmbH
 Ismaninger Straße 63
 81675 Munich
 Germany

Exhibitor
Contact
Address
Postal Code, City/Town
Phone Number
Fax Number
Mobile Phone Number
E-mail Address
Internet



Deadline to send in this form: 3 May 2010

1.1 Electrical Connection (Please do not fail to fill out!)

This is the form for the electrical mains connection. Main distribution boards (breaker panels) may either be brought or ordered. Schematic diagrams for electrical distribution boards can be found on form 1.3.

We hereby submit a binding order on the basis of the Terms of Participation of TrendSet:

The prices for the electrical mains connection include power consumption and earthing (grounding) of the stand.

<input type="checkbox"/>	Up to 3 kW (only alternating current, no direct current) Including Distribution Board 1			165.00 EUR
<input type="checkbox"/>	Up to 5 kW	<input type="checkbox"/> Distribution Board 4	<input type="checkbox"/> CEE socket	290.00 EUR
<input type="checkbox"/>	Up to 7 kW	<input type="checkbox"/> Distribution Board 4	<input type="checkbox"/> CEE socket	348.00 EUR
<input type="checkbox"/>	Up to 10 kW	<input type="checkbox"/> Distribution Board 4	<input type="checkbox"/> CEE socket	412.00 EUR
<input type="checkbox"/>	Up to 15 kW	<input type="checkbox"/> Distribution Board 4	<input type="checkbox"/> CEE socket	537.00 EUR
<input type="checkbox"/>	From 20 kW	<input type="checkbox"/> CEE 32A socket		619.00 EUR
<input type="checkbox"/>	From 30 kW	<input type="checkbox"/> CEE 63A socket		815.50 EUR
<input type="checkbox"/>	Larger distribution boards	<input type="checkbox"/> Distribution Board 2		additionally 126.80 EUR
	Instead of Distribution Board 4	<input type="checkbox"/> Distribution Board 3		additionally 324.20 EUR

The connections up to 15 kW include 230 V/400 V, 50 Hz; electrical power consumption included.

This electrical mains connection includes the supply line to the stand, but not the main distribution board. The main distribution board (breaker panel) may either be brought or ordered extra. If you bring your own distribution board, you must bring a ground fault circuit interrupter.

Depending on the type or style of stand construction or stand design, one or more connections to the earth/ground wires (earthing/potential equalisation) in accordance with DIN EN VDE 0100 are required.

Please note:

Processing of this order is possible only with a plan or sketch. Please use one of the enclosed stand sketch templates for this. Orders received after the deadline will be charged a processing fee of 85.00 EUR.

Place, Date

Signature

10. - 12. July 2010

96th TrendSet — International Trade Fair for Living, Dining, Lifestyle

TrendSet GmbH
 Ismaninger Straße 63
 81675 Munich
 Germany

Exhibitor
Contact
Address
Postal Code, City/Town
Phone Number
Fax Number
Mobile Phone Number
E-mail Address
Internet



Deadline to send in this form: 3 May 2010

1.2 Electrical Connection (Accessories)

We hereby submit a binding order on the basis of the Terms of Participation of TrendSet:

Stand lighting

<input type="checkbox"/>	Spotlight, incandescent bulb (32800) Up to 100 W Quantity <input type="text"/>	each	28.50 EUR
<input type="checkbox"/>	Stem light (spotlight with cantilever arm), incandescent bulb (32801) Up to 100 W Quantity <input type="text"/>	each	33.00 EUR
<input type="checkbox"/>	Halogen spotlight (32805) 1.500 W Quantity <input type="text"/>	each	81.00 EUR
<input type="checkbox"/>	Electrical installation (32850) Labour cost/hour for additional electrical installations	price/hour	47.60 EUR

The additional stand installation includes all electrical installation services starting from the electrical main distribution. For items which are calculated on a time and materials basis, the following item prices form the basis. Larger-scale stand installations may be calculated according to a quotation.

The per-piece and rental prices respectively include the rental licence of materials, delivery and installation.

The schematic diagrams for stand lighting can be found on form 1.3.

Please note:

Processing of this order is possible only with a plan or sketch. Please use one of the enclosed stand sketch templates for this.

Orders received after the deadline will be charged a processing fee of 85.00 EUR.

Place, Date

Signature

1.3 Electrical Connection (Diagrams)

Power Distribution Boards

Below are a description and schematic representation of Distribution Board 1, which is included in the 3 kW electrical mains connection, as well as Distribution Board 4, which is included in electrical mains connections up to 15 kW.

Distribution Board 1	Distribution Board 2	Distribution Board 3	Distribution Board 4
<p>2 sockets for alternating current devices, 1 socket (6 A) for uninterrupted power supply (alternating current)</p>	<p>5 sockets for alternating current devices, 1 socket (6 A) for uninterrupted power supply (alternating current)</p>	<p>9 sockets for alternating current devices, 1 socket (6 A) for uninterrupted power supply (alternating current)</p>	<p>1 CEE socket (16 A) for 230 V/400 V, 50 Hz connection (direct current), 2 sockets for alternating current devices, 1 socket (6 A) for uninterrupted power supply (alternating current)</p>
<p>Included in the price for a 3 kW connection</p>	<p>price 126.80 EUR</p>	<p>price 324.20 EUR</p>	<p>Included in price for 5 kW to 15 kW connections</p>
<p>Board dimensions: W 170 mm x H 660 mm x D 70 mm</p>	<p>Board dimensions: B 170 mm x H 660 mm x D 70 mm</p>	<p>Board dimensions: B 300 mm x H 950 mm x D 210 mm</p>	<p>Board dimensions: B 170 mm x H 660 mm x D 70 mm</p>

Stand lighting

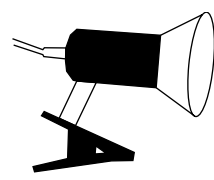

32800
each **28.50 EUR**

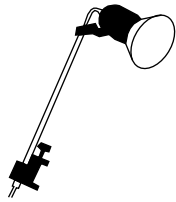

32801
each **33.00 EUR**

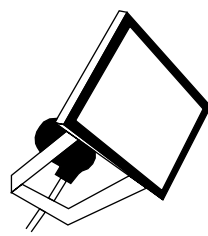

32805
each **81.00 EUR**

10. - 12. July 2010

96th TrendSet — International Trade Fair for Living, Dining, Lifestyle

TrendSet GmbH
 Ismaninger Straße 63
 81675 Munich
 Germany

Exhibitor
Contact
Address
Postal Code, City/Town
Phone Number
Fax Number
Mobile Phone Number
E-mail Address
Internet

Deadline to send in this form: 3 May 2010

2.1 Stand Type/Construction (Please do not fail to fill out!)

For planning stands, we need to know if you are using a modular stand and if you need partition panels facing your stand neighbours.

Modular stands

Please choose one answer.

<input type="checkbox"/>	We have a modular stand or our own stand construction system.
<input type="checkbox"/>	We do not have a modular stand and we do not have our own stand construction system.

Partition panels (white) to stand neighbours

Please choose one answer.

<input type="checkbox"/>	We require stand partition panels to the neighbours, or back panels to the hall wall (free of charge).
<input type="checkbox"/>	We do not require stand partition panels or back walls to the stand neighbour.

We hereby submit a binding order on the basis of the Terms of Participation of TrendSet:

<input type="checkbox"/>	Stand walls in colour <input type="checkbox"/> Red <input type="checkbox"/> Blue <input type="checkbox"/> Black <input type="checkbox"/> Light grey <input type="checkbox"/> Dark grey <input type="checkbox"/> Custom colour Price for custom colour on request. Please enclose colour sample. Quantity <input type="text"/> running meter(s)	per running meter	51.00 EUR
<input type="checkbox"/>	Support track for attaching spotlights (must be supported when 4 m or longer) Quantity <input type="text"/> running meter(s)	per running meter	15.00 EUR

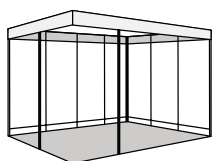

Stand construction in aluminum components without fascia board, grid ceiling, carpeting

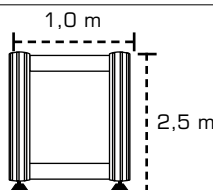

White panels, plastic coated, Height 2.5 m, width 1.0 m, thickness 5.0 cm

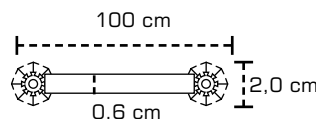

Rail to attach hooks; rail outer dimension 2.0 cm, inner 0.6 cm (seen from above)

Please note:

Processing of this order is possible only with a plan or sketch. Please use one of the enclosed stand sketch templates for this. Prices are subject to change by Munich International Trade Fairs. Partition panels, supporting walls, doors, and fascia boards may not be rebuilt or dismantled independently by exhibitors. Possible damage or loss will be billed to the exhibitor. Orders received after the deadline will be charged a processing fee of 85.00 EUR.

Place, Date

Signature

10. - 12. July 2010

96th TrendSet — International Trade Fair for Living, Dining, Lifestyle

TrendSet GmbH
Ismaninger Straße 63
81675 Munich
Germany

Exhibitor
Contact
Address
Postal Code, City/Town
Phone Number
Fax Number
Mobile Phone Number
E-mail Address
Internet

bijoutex
fachmesse münchen

Deadline to send in this form: 3 May 2010

2.2 Additional Fittings

We hereby submit a binding order on the basis of the Terms of Participation of TrendSet:

<input type="checkbox"/>	Additional panels for building a closet/decorative wall Plastic panel (white) with metal frame, 50 cm/100 cm x 250 cm Quantity <input type="text"/>	per running meter	26.00 EUR
<input type="checkbox"/>	Additional coloured panels for building a closet/decorative wall <input type="checkbox"/> Red <input type="checkbox"/> Blue <input type="checkbox"/> Black <input type="checkbox"/> Light grey <input type="checkbox"/> Dark grey Price for custom colour on request. Please enclose colour sample. Quantity <input type="text"/>	per running meter	79.00 EUR
<input type="checkbox"/>	Perforated panel 100 cm x 250 cm Quantity <input type="text"/>	each	45.00 EUR
<input type="checkbox"/>	Closet door, lockable Plastic (white) with metal frame, 100 cm x 250 cm Quantity <input type="text"/>	each	70.00 EUR
<input type="checkbox"/>	Fascia board for lettering (must be supported at 4 m or longer) including support frame Plastic (white), 100 cm x 30 cm Quantity <input type="text"/>	each	40.00 EUR

Shelves to hang in the modular stand system

<input type="checkbox"/>	Angled shelf (100 cm x 30 cm) Quantity <input type="text"/>	each	25.00 EUR
<input type="checkbox"/>	Shelf (100 cm x 30 cm) Quantity <input type="text"/>	each	20.00 EUR

Please note:

Processing of this order is possible only with a plan or sketch. Please use one of the enclosed stand sketch templates for this. Prices are subject to change by Munich International Trade Fairs. Partition panels, supporting walls, doors, and fascia boards may not be rebuilt or dismantled independently by exhibitors. Possible damage or loss will be billed to the exhibitor. Orders received after the deadline will be charged a processing fee of 85.00 EUR.

Place, Date

Signature

10. - 12. July 2010

96th TrendSet — International Trade Fair for Living, Dining, Lifestyle

TrendSet GmbH
Ismaninger Straße 63
81675 Munich
Germany

Exhibitor
Contact
Address
Postal Code, City/Town
Phone Number
Fax Number
Mobile Phone Number
E-mail Address
Internet

bijoutex
fachmesse münchen

Deadline to send in this form: 3 May 2010

3 Stand Assembly

We hereby submit a binding order on the basis of the Terms of Participation of TrendSet:

<input type="checkbox"/> Early stand assembly Wednesday, 7 July 2010	125.00 EUR
--	-------------------

Please note:

Early stand assembly is possible only after written request to and subsequent confirmation by TrendSet GmbH.

The standard stand assembly will take place on:

Thursday, 8 July 2010

Friday, 9 July 2010

For exact times, please refer to the guidelines for stand assembly and dismantling.

Place, Date

Signature

10. - 12. July 2010

96th TrendSet — International Trade Fair for Living, Dining, Lifestyle

TrendSet GmbH
Ismaninger Straße 63
81675 Munich
Germany

Exhibitor
Contact
Address
Postal Code, City/Town
Phone Number
Fax Number
Mobile Phone Number
E-mail Address
Internet

bijoutex
fachmesse münchen

Deadline to send in this form: 3 May 2010

4.1 Carpeting

We request that TrendSet GmbH forward the following order in our name to the contractor named below. The contractual relationship comes into effect between the orderer and the contractor EXPOMAX LD Dienstleistungs GmbH, Vorgebirgsstr. 28, 50389 Wesseling, Germany, Phone: +49 · (0)2236 · 3226 - 0, Telefax: +49 · (0)2236 · 3226 - 20, mail: info@expomax.de. The order is according to the conditions listed below.

<input type="checkbox"/> Expofilz rolls (including film cover)	price/m²	5.50 EUR
Standgröße und Standart		
<input type="text"/> m	x	<input type="text"/> m
total	<input type="text"/>	sq m
<input type="checkbox"/> Row stand	<input type="checkbox"/> Corner stand	<input type="checkbox"/> Peninsula stand
<input type="checkbox"/> Island stand		
Colours		
<input type="checkbox"/> Azur (7904)	<input type="checkbox"/> Graphite (7965)	<input type="checkbox"/> Orange (7347)
<input type="checkbox"/> Blue (7824)	<input type="checkbox"/> Green (7901)	<input type="checkbox"/> Red (7962)
<input type="checkbox"/> Dark brown (7248)	<input type="checkbox"/> Light brown (7956)	<input type="checkbox"/> Sand (7916)
<input type="checkbox"/> Dark green (7831)	<input type="checkbox"/> Light grey (7915)	<input type="checkbox"/> Black (7910)
<input type="checkbox"/> Dark red (7522)	<input type="checkbox"/> Light green (7961)	<input type="checkbox"/> Tomato (7662)
<input type="checkbox"/> Yellow (7213)	<input type="checkbox"/> Navy (7954)	<input type="checkbox"/> White (7950)

Latest date and time to lay carpeting:	<input type="text"/>
Date	<input type="text"/>
Time	<input type="text"/>
Comment	<input type="text"/>
No carpet laying is possible before 8 July 2010.	

Delivery and Payment Conditions

1. The scope of delivery is binding. An exchange of services is not possible. Not taking advantage of individual services does not lead to a reduction in price. Adding to the service package is possible only for an additional fee.
2. Complaints must be registered by the first day of the exhibition. They will be remedied exclusively by rework.
3. The renter is liable for property damage arising during the rental period.
4. The price includes the rental assignment of the materials, installation, and deinstallation, all transport and warehousing for the length of the exhibition.

Please note:

Processing of this order is possible only with a plan or sketch. Please use one of the enclosed stand sketch templates for this.
Orders received after the deadline will be charged a processing fee of 85.00 EUR.

Place, Date

Signature

4.2 Colour Choices for Carpeting



Azur (7904)



Graphite (7965)



Orange (7347)



Blue (7824)



Green (7901)



Red (7962)

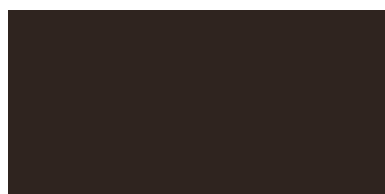

Dark brown (7248)



Light brown (7956)

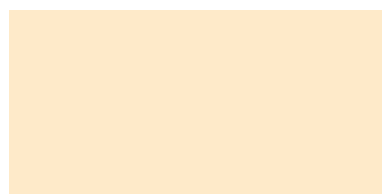

Sand (7916)



Dark green (7831)



Light grey (7915)

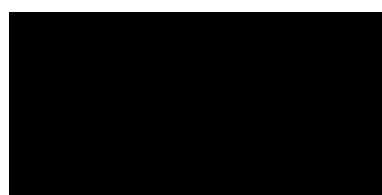

Black (7910)



Dark red (7522)



Light green (7961)



Tomato (7662)



Yellow (7213)



Navy (7954)

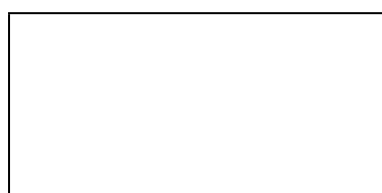

White (7950)

10. - 12. July 2010

96th TrendSet — International Trade Fair for Living, Dining, Lifestyle

TrendSet GmbH
 Ismaninger Straße 63
 81675 Munich
 Germany

Exhibitor
Contact
Address
Postal Code, City/Town
Phone Number
Fax Number
Mobile Phone Number
E-mail Address
Internet



Deadline to send in this form: 3 May 2010

5.1 Furniture—Chairs

We hereby submit a binding order on the basis of the Terms of Participation of TrendSet:

<input type="checkbox"/>	Plastic stacking chair (St03) Quantity <input type="text"/>	each	10.50 EUR
<input type="checkbox"/>	Bistro chair (St06) <input type="checkbox"/> white/white <input type="checkbox"/> black/beige Quantity <input type="text"/>	each	14.00 EUR
<input type="checkbox"/>	Plastic shell chair (St08) <input type="checkbox"/> orange <input type="checkbox"/> black <input type="checkbox"/> transparent <input type="checkbox"/> ivory Quantity <input type="text"/>	each	24.00 EUR
<input type="checkbox"/>	Padded chair (St11) <input type="checkbox"/> blue <input type="checkbox"/> grey <input type="checkbox"/> black Quantity <input type="text"/>	each	16.00 EUR
<input type="checkbox"/>	Barstool (Bh03) Z-Form, black Quantity <input type="text"/>	each	21.50 EUR
<input type="checkbox"/>	Barstool (Bh04) Frame runners, grey Quantity <input type="text"/>	each	30.00 EUR

The schematic diagrams of furniture can be found on form 5.4.

Please note:

Orders received after the deadline will be charged a processing fee of 85.00 EUR and an additional fee of 50%.

Place, Date

Signature

10. - 12. July 2010

96th TrendSet — International Trade Fair for Living, Dining, Lifestyle

TrendSet GmbH
 Ismaninger Straße 63
 81675 Munich
 Germany

Exhibitor
Contact
Address
Postal Code, City/Town
Phone Number
Fax Number
Mobile Phone Number
E-mail Address
Internet



Deadline to send in this form: 3 May 2010

5.2 Furniture—Tables

We hereby submit a binding order on the basis of the Terms of Participation of TrendSet:

<input type="checkbox"/>	Table (T05) 80 x 80 cm, 72 cm high, marbled grey Quantity <input type="text"/>	each	24.50 EUR
<input type="checkbox"/>	Table (T08) Ø 80 cm, 74 cm high, white Quantity <input type="text"/>	each	32.00 EUR
<input type="checkbox"/>	Folding table (K03) 200 cm x 50 cm, 80 cm high Quantity <input type="text"/>	each	14.00 EUR
<input type="checkbox"/>	Bistro table (T13) Ø 60 cm, 107 cm high, grey Quantity <input type="text"/>	each	47.00 EUR
<input type="checkbox"/>	Bistro table (T15) Ø 70 cm, 110 cm high, white Quantity <input type="text"/>	each	36.00 EUR
<input type="checkbox"/>	Bistro table, foldable (T30) Ø 70 cm, 110 cm high, white Quantity <input type="text"/>	each	25.00 EUR

The schematic diagrams of furniture can be found on form 5.4.

Please note:

Orders received after the deadline will be charged a processing fee of 85.00 EUR and an additional fee of 50%.

Place, Date

Signature

10. - 12. July 2010

96th TrendSet — International Trade Fair for Living, Dining, Lifestyle

TrendSet GmbH
 Ismaninger Straße 63
 81675 Munich
 Germany

Exhibitor
Contact
Address
Postal Code, City/Town
Phone Number
Fax Number
Mobile Phone Number
E-mail Address
Internet



Deadline to send in this form: 3 May 2010

5.3 Other Furniture

We hereby submit a binding order on the basis of the Terms of Participation of TrendSet:

<input type="checkbox"/>	Sideboard (SB) 90 x 45 cm, 80 cm high Quantity <input type="text"/>	each	63.00 EUR
<input type="checkbox"/>	Cabinet with top section (TS) 100 x 50cm, 108 cm high Quantity <input type="text"/>	each	78.00 EUR
<input type="checkbox"/>	Refrigerator (KS140) 55 x 60 cm, 85 cm high Quantity <input type="text"/>	each	52.00 EUR
<input type="checkbox"/>	Literature rack (PO1) 80 cm wide, 140 cm high Quantity <input type="text"/>	each	34.00 EUR
<input type="checkbox"/>	Glass display case, lockable, with lighting approx. 104.5 cm x 55 cm x 180 cm (width/depth/height), glass height 1.1 m Quantity <input type="text"/>	each	130.00 EUR

<input type="checkbox"/>	Please send us the documentation showing more rental furniture.
--------------------------	--

The schematic diagrams of furniture can be found on form 5.4.

Please note:

Orders received after the deadline will be charged a processing fee of 85.00 EUR and an additional fee of 50%.

Place, Date

Signature

5.4 Furniture (Diagrams)

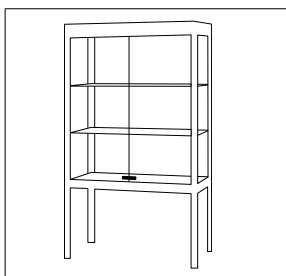
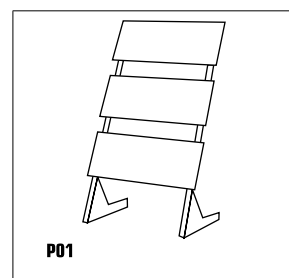
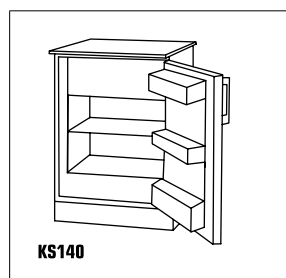
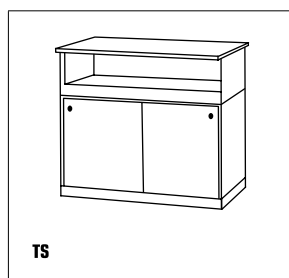
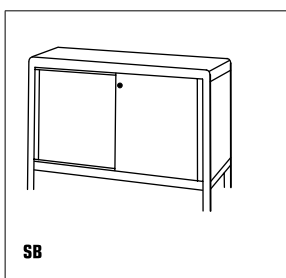
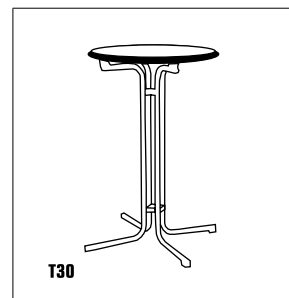
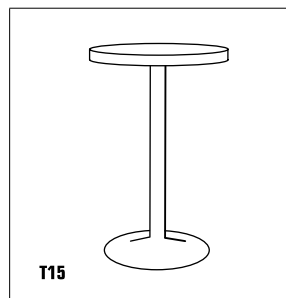
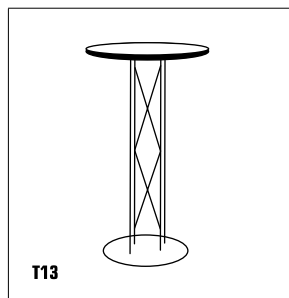
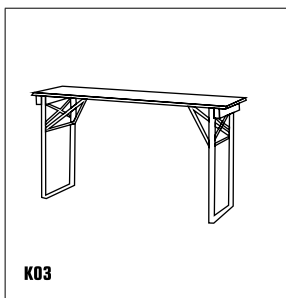
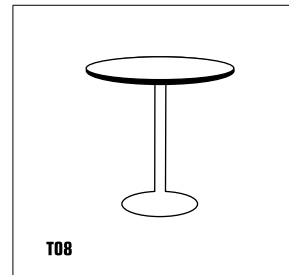
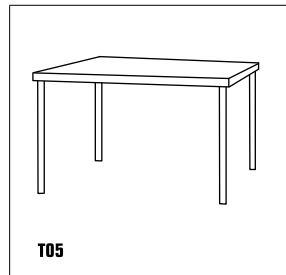
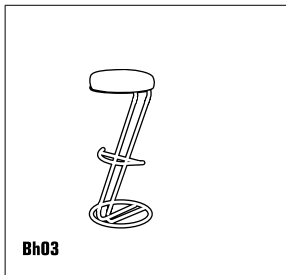
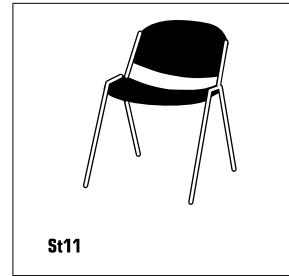
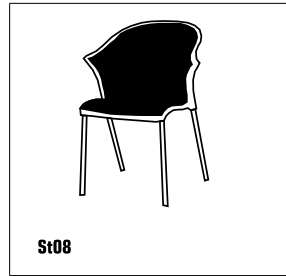
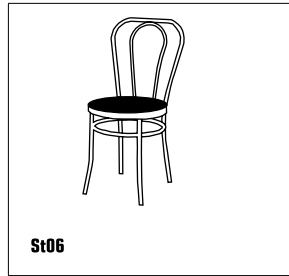

10. - 12. July 2010

96th TrendSet — International Trade Fair for Living, Dining, Lifestyle

TrendSet GmbH
 Ismaninger Straße 63
 81675 Munich
 Germany

Exhibitor
Contact
Address
Postal Code, City/Town
Phone Number
Fax Number
Mobile Phone Number
E-mail Address
Internet



Deadline to send in this form: 3 May 2010

6 Telecommunications Connection

We hereby submit a binding order on the basis of the Terms of Participation of TrendSet:

<input type="checkbox"/>	Combination package (34003) with end device 1 full-featured device (digital), 1 fax machine (analog) Quantity <input type="text"/>	each 345.00 EUR
<input type="checkbox"/>	Digital connection (34005) with end device 1 full-featured device, no connection possibility for analog devices (e.g. fax machine, answering machine) Quantity <input type="text"/>	each 126.50 EUR
<input type="checkbox"/>	Analog extension connection (34014) for fax/modem Quantity <input type="text"/>	each 103,00 EUR
<input type="checkbox"/>	ISDN connection for multiple devices (34055) Quantity <input type="text"/>	each 325.00 EUR
<input type="checkbox"/>	Mobile telephone DECT (34006) Quantity <input type="text"/>	each 114.00 EUR
<input type="checkbox"/>	Fax machine (34012) for standard paper Quantity <input type="text"/>	each 280.50 EUR
Internet access		
WLAN card for 1 hour		5.00 EUR
WLAN card for 2 hours		10.00 EUR
WLAN card for 8 hours		30.00 EUR
WLAN cards are available in the trade fair office during the official stand assembly time (Prices subject to change.)		

Please note:

Processing of this order is possible only with a plan or sketch. Please use one of the enclosed stand sketch templates for this.

Orders received after the deadline will be charged a processing fee of 85.00 EUR.

Place, Date

Signature

10. - 12. July 2010

96th TrendSet — International Trade Fair for Living, Dining, Lifestyle

TrendSet GmbH
 Ismaninger Straße 63
 81675 Munich
 Germany

Exhibitor
Contact
Address
Postal Code, City/Town
Phone Number
Fax Number
Mobile Phone Number
E-mail Address
Internet



Deadline to send in this form: 3 May 2010

7 Water Connection

We hereby submit a binding order on the basis of the Terms of Participation of TrendSet:

<input type="checkbox"/>	Main water connection (38100) Intake (supply) 1/2", drain DN 50, installation of connection (water consumption currently flat rate of 33.00 EUR)	each 288.00 EUR
Quantity	<input type="text"/>	
<input type="checkbox"/>	Connections for additional consumers (38050) Sink, automatic dishwasher, boiler, etc.	each 48.50 EUR
Quantity	<input type="text"/>	
<input type="checkbox"/>	Rental sink unit (38051) Sink with cabinet, faucet, 5 liter electric boiler	each 122.00 EUR
Quantity	<input type="text"/>	
<input type="checkbox"/>	We are installing a platform, stage, or podium at our stand. The clear height between hall floor and platform is approx. <input type="text"/> cm.	
<input type="checkbox"/>	Water installation (38090) Labour cost/hour for additional installation work.	price/hour 47.50 EUR

Please note:

When using commercial automatic dishwashers, or producing and/or demonstrating the use of products containing oil or fat, as well as when serving more than 30 portions of food a day, the accrued wastewater is to be led through a fat separator. Processing of this order is possible only with a plan or sketch. Please use one of the enclosed stand sketch templates for this. Orders received after the deadline will be charged a processing fee of 85.00 EUR.

Place, Date

Signature

10. - 12. July 2010

96th TrendSet — International Trade Fair for Living, Dining, Lifestyle

TrendSet GmbH
Ismaninger Straße 63
81675 Munich
Germany

Exhibitor
Contact
Address
Postal Code, City/Town
Phone Number
Fax Number
Mobile Phone Number
E-mail Address
Internet

bijoutex
fachmesse münchen

Deadline to send in this form: 3 May 2010

8 Badges (Identification Cards)

We hereby submit a binding order on the basis of the Terms of Participation of TrendSet:

The basic price includes badges. The number of badges depends on the square meter of the stand.

up to 25 sq m	>>>	4 badges
up to 35 sq m	>>>	5 badges
up to 45 sq m	>>>	6 badges
each further 10 sq m	>>>	an additional badge

<input type="checkbox"/> Additional exhibitor badges each 16.00 EUR
In addition to the badges included in the base price, we are ordering
Quantity <input type="text"/> extra badges.

Place, Date

Signature

10. - 12. July 2010

96th TrendSet — International Trade Fair for Living, Dining, Lifestyle

TrendSet GmbH
 Ismaninger Straße 63
 81675 Munich
 Germany

Exhibitor
Contact
Address
Postal Code, City/Town
Phone Number
Fax Number
Mobile Phone Number
E-mail Address
Internet

Deadline to send in this form: 3 May 2010

9 Trend Display Cubicle or Glass Display Case Between Hallsgang

Only one display cubicle or display case per exhibitor may be ordered. The awarding of the limited number of display cubicles and cases occurs according to the date the order is received. Placement is carried out by the management of the fair.

We hereby submit a binding order on the basis of the Terms of Participation of TrendSet:

<input type="checkbox"/>	Display cubicle including lighting approx. 1.5 m x 1.0 m x 2.5 m (width/depth/height)	195.00 EUR
<input type="checkbox"/>	Glass display case, lockable, with lighting approx. 1.0 m x 0.5 m x 1.8 m (width/depth/height), height of glass 1.1 m	195.00 EUR

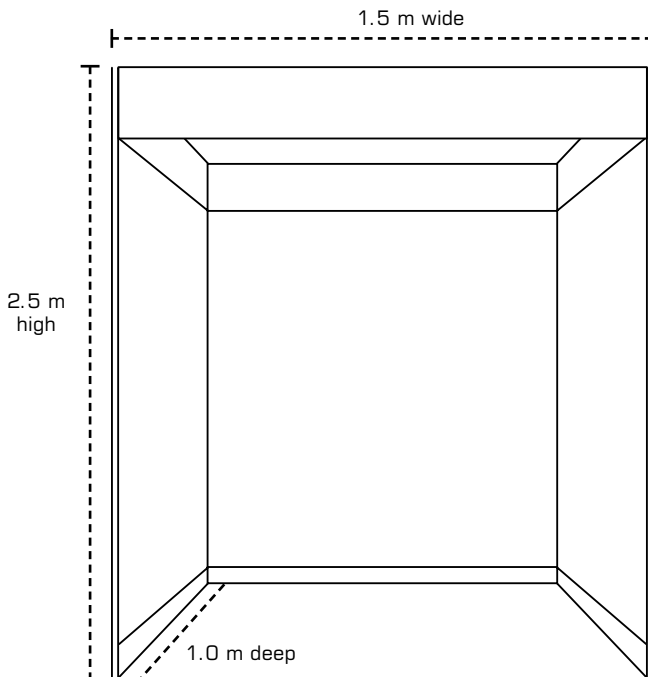

Display Cubicle

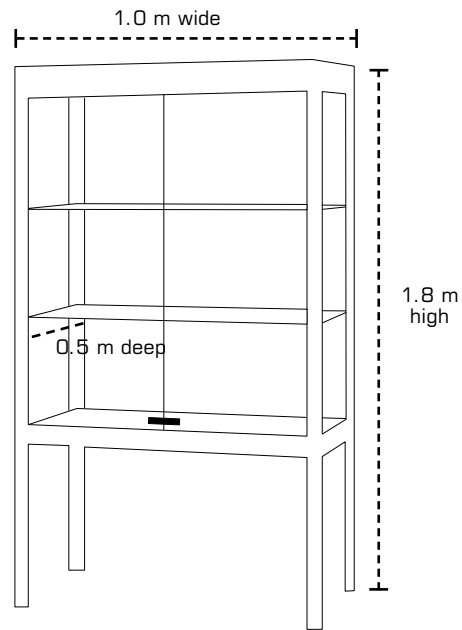

Glass Display Case

Place, Date

Signature

10. - 12. July 2010

96th TrendSet — International Trade Fair for Living, Dining, Lifestyle

TrendSet GmbH
Ismaninger Straße 63
81675 Munich
Germany

Exhibitor
Contact
Address
Postal Code, City/Town
Phone Number
Fax Number
Mobile Phone Number
E-mail Address
Internet



Deadline to send in this form: 3 May 2010 10 Additional Services

We request that TrendSet GmbH send us the following documents.

Suspensions

If needed, please request our form for the suspension construction in a hall.

Please send us the documentation for hanging suspensions to the following fax number.
Fax number

Stand security staff (guard)

Please send us the documentation for security staff to the following fax number.
Fax number

Assistance finding temporary stand personnel (job service)

Please send us the documentation for the employment agency to the following fax number.
Fax number

Cleaning of the stand

Please send us the documentation for stand cleaning to the following fax number.
Fax number

Place, Date

Signature